

MOISTURE PERFORMANCE AND VERTICAL MOVEMENT MONITORING OF PRE-FABRICATED CROSS LAMINATE TIMBER – FEATURED CASE STUDY: UBC TALLWOOD HOUSE

G. Mustapha, K. Khondoker, J. Higgins

ABSTRACT

Wood structures such as the Wood Innovation and Design Center in Prince George and the UBC Tallwood House, an 18 storey, 53-meter-tall mass timber hybrid building are examples of new and innovative wood structures that encompass new construction techniques, unique materials and novel building practices. Empirical data on the condition of critical components and access to the real-time status of the structure during construction gives Architects, Engineers and Contractors critical information to make informed decisions to either validate or improve the construction plan. Data recorded during the life of the building helps validate the design decisions and proves the viability and feasibility of the design. Methods and practices used to monitor both the moisture performance of pre-fabricated cross laminate timber (CLT) as well as the vertical movement sensing of the building during and after construction are explored in this paper. Moisture content of the CLT panels has been recorded from manufacturing and prefabrication to storage, through transport and during installation and will continue throughout the service life of the building.

The calculated and expected displacement of the wood columns is scheduled to take several years as the structure settles, however a first-year analysis and extrapolation of the data was conducted. Monitoring during transport, storage, and construction proved that CLT panels were resilient to moisture issues while in the manufacturers storage, but prone to direct exposure to moisture-related problems regardless of the precautions taken on site. Despite construction during typical Pacific Northwest rain, informed decisions were made to ensure the panel moisture content could decrease to acceptable ranges before continuing to secondary construction phases. The moisture trends observed in the building were proportional to the control samples as both were subjected to similar environmental conditions.

INTRODUCTION

The use of engineered wood products to build larger wood buildings is becoming more prevalent over recent years (Wang, 2015). As mass timber structures move to the forefront of sustainable design, construction methods to economically and continuously monitor these structures for key performance indicators are extremely valuable. This paper used research performed on UBC Brock Commons Tallwood House as a case study in an exploration of various remote monitoring methods with an analysis of the first year of data collected from the building.

Research was conducted to evaluate the moisture performance of prefabricated cross laminated timber (CLT) from the manufacturing plant, during transport and storage and during the construction process. A vertical

displacement monitoring system was also instrumented throughout the building to gauge a better understanding of the short and long term settling of the timber structure throughout construction and active use. These areas of study were deemed important to gaining a broader understanding of using engineered mass timber as a common building material. Analysis of the data can be used for future projects by designers, contractors, and building owners for which appropriate considerations will need to be made for their respective projects.

CLT TRANSPORTATION STUDY

The Tallwood House project implemented a streamlined kit-of-parts approach to constructing the structural components of the building (Fraser, 2016). In this, the CLT panels were cut precisely to the dimensions required for installation. This included every opening and cut necessary for all aspects of the construction process (Sills 2016). Once each panel was manufactured they were coated with a urethane resin sealer, Miralite, on the panel faces as well as a wax coating on hole and end-grain surfaces for moisture control. Panels were transported to the construction site on the day they were intended to be installed. Instrumentation of the panels was done to observe the effects of changing conditions on moisture performance on the CLT through storage and transport.

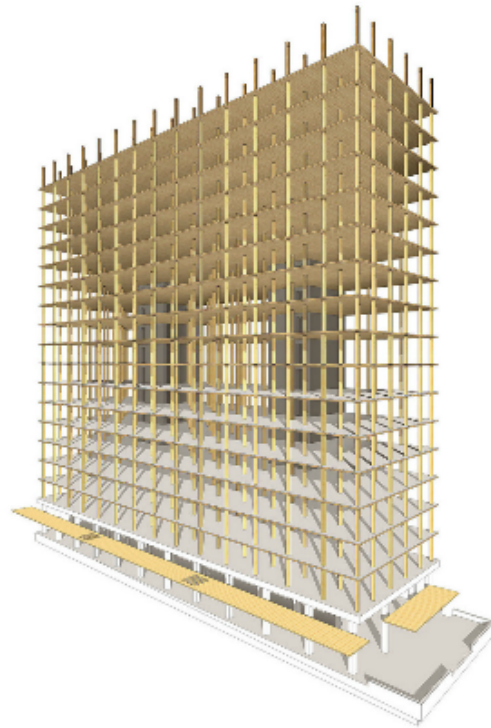

Figure 1: UBC Tallwood House (Image from Acton Ostry Architects)

Trips were made to the CLT manufacturing plant in Penticton, BC on May 5, 2016 and May 27, 2016 to outfit CLT offcuts with sensor arrays. Preparations were made to store and transport the offcuts in the same manner as the CLT panels to be used in the Brock Commons Tallwood House.

During the first trip, 2 large offcuts were outfitted with sensors, as well as 2 smaller CLT blocks. During the second trip, 6 large offcuts were instrumented and stored. All offcuts were coated with the same products and in the same manner as the full-size floor panels. The offcuts were then wrapped in plastic, stacked and stored alongside the full-size panels. Wood slats were placed in between each panel to increase airflow to the panels and prevent any potential moisture buildup, similar to how the full-size floor panels were stored.

Transportation Instrumentation

Sensor locations were chosen with the aim of acquiring a diverse set of data, avoiding interior joints, and avoiding material imperfections since probes hitting wood imperfections or interior joints could yield inconsistent results.

Detailed in Figure 2 a number system corresponding with drill depth was developed with #1 being the midpoint of the topmost layer and #5 being the depth of the bottom ply. Depths 1 and 2 utilized 200mm

probes, depths 3 and 4 110 mm probes, and 5 a 40mm probe. Thermistors were installed to depth 3 at the center of the panel, and to depth 1 at the top face.

The CLT panel grain orientation changes with each layer. Probes were installed parallel to the grain of the testing layer to gather consistent data.

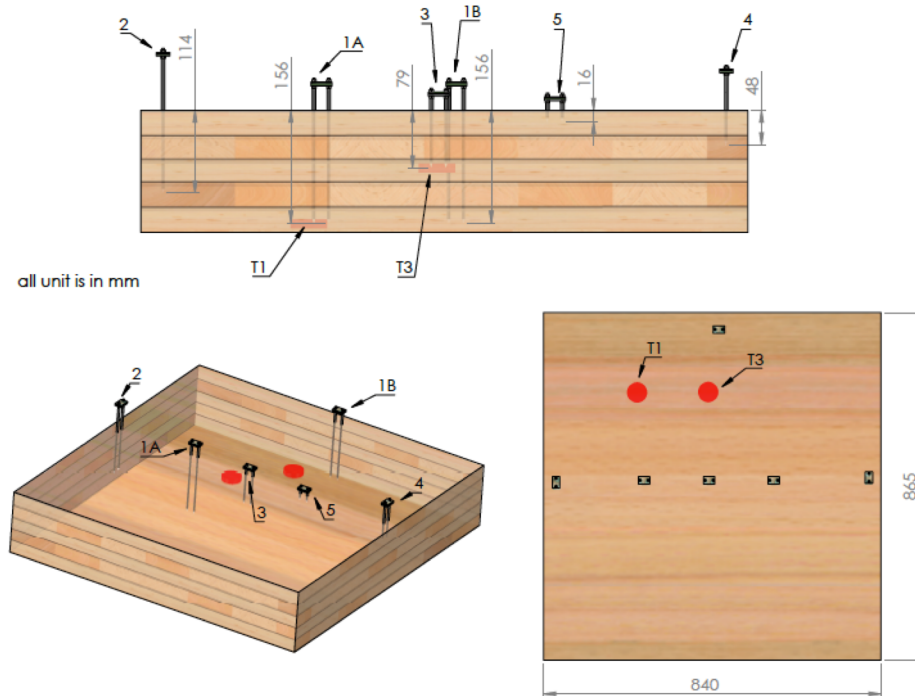

Figure 2: Probe Locations and Orientation



Figure 3: Instrumented Off-cuts – May 7th, 2016-06-01



Figure 4: Off-cuts Stored outside alongside full size CLT panels



Figure 5: Six additional off-cuts were instrumented on May 27th, 2016-06-01

Transport

The offcuts were continuously monitored as they were transported from the CLT manufacturing storage facility in Penticton to the construction site at UBC. On site, long term storage was an impossibility due to site area restrictions. The process of shipment from the CLT manufacturing plant to being lifted for building installation occurred in a one-day window. Panels were stored on the trucks during transport in the precise order of installation (Sills, 2016). When panels arrived for installation, the protective plastic was removed, and placed on the supporting columns already installed in the building. From this point, the environment that they were stored in was no longer controlled and the CLT was exposed to environmental factors until the building was fully enclosed. To reflect this process accurately, transportation samples A and B were uncovered and left uncovered to be exposed to the rain and sun.

The timeline and path of travel for the transportation CLT samples are as shown in Figure 6 and Figure 7 below. Samples were shipped with different floor panel shipments to create a diverse set of data with the possibility of varying environmental and logistical conditions.

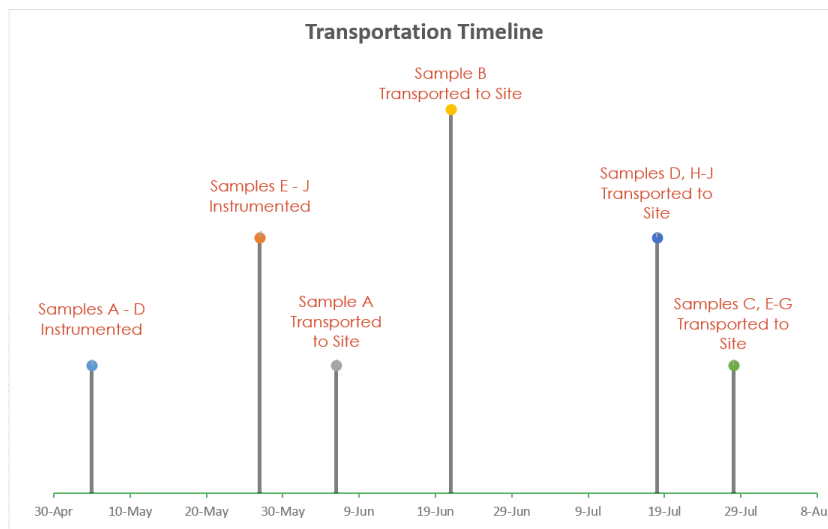

Figure 6: Transportation Timeline of Samples

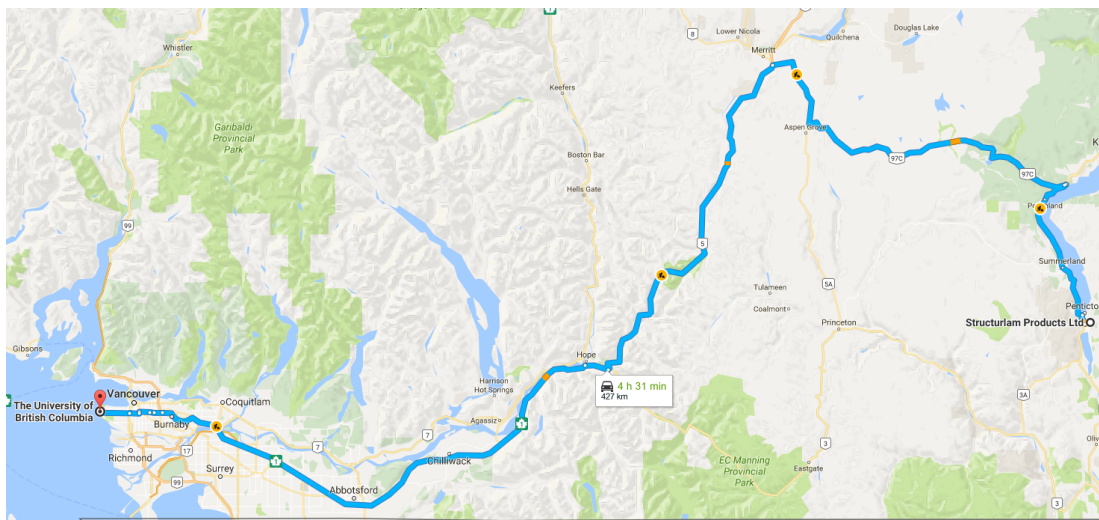

Figure 7: CLT Path to Site

Data Collection and Analysis

Moisture and Temperature data were collected by the wireless data loggers connected to each panel. These devices stored data regardless of where the sample was located and transmitted the data to the Internet upon arriving on-site. Results from 60 moisture content sensors at varying depths and 20 temperature sensors are shown in Figure 8.

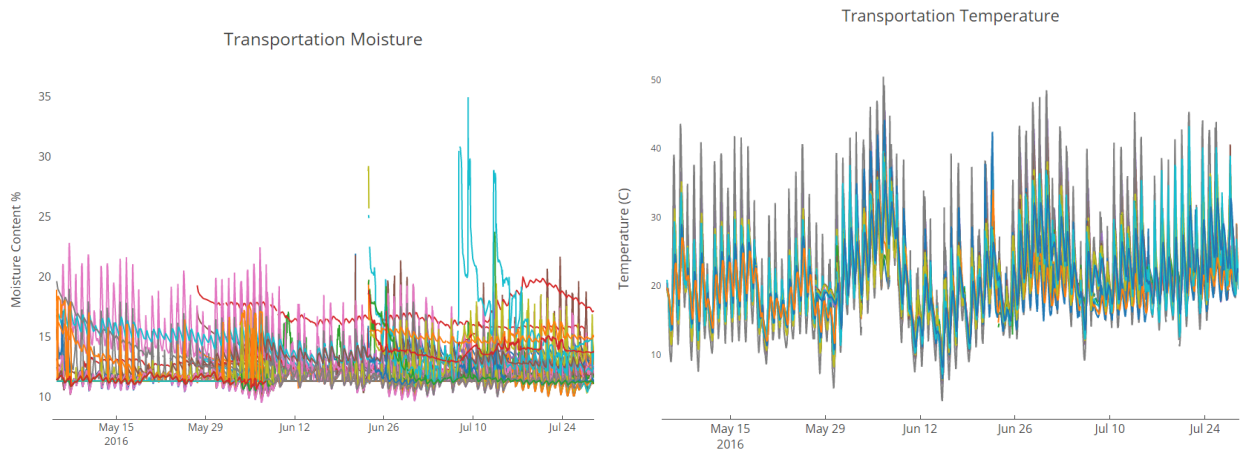

Figure 8: Transportation Moisture and Temperature Data

Data from Transportation Sample A which arrived and was uncovered to reflect the conditions of the CLT of the structure showed the effectiveness of the processes the CLT manufacturer implemented while storing and transporting the CLT panels for this project. As seen in Figure 9 prior to shipping, moisture levels in the CLT samples stayed very consistent and were did not appear to be exposed to moisture.

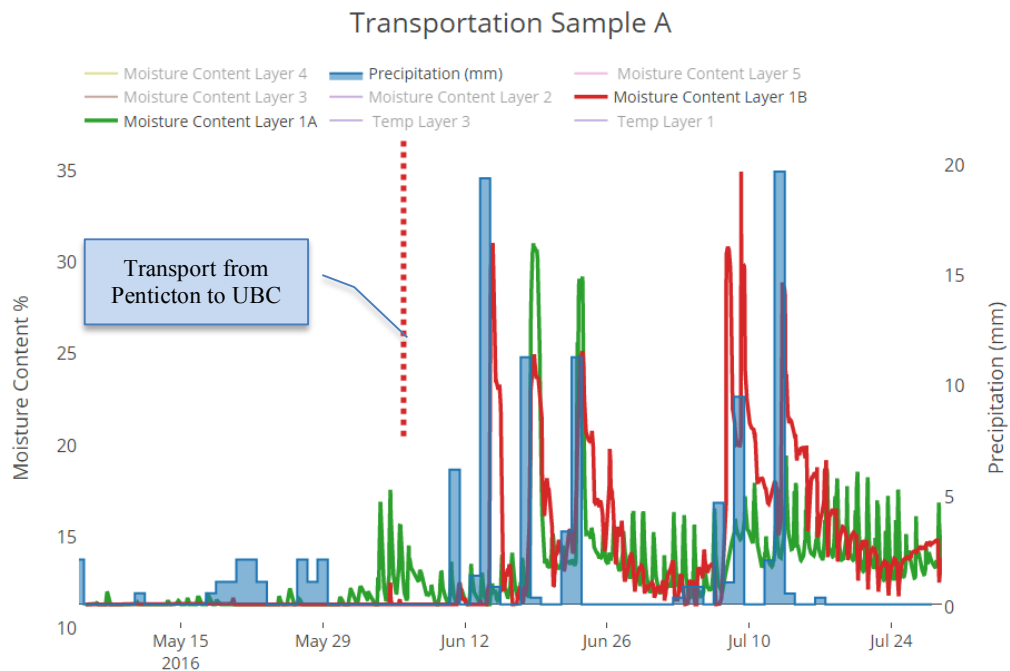

Figure 9: Analysis of Sample A during Transport

Once uncovered and exposed to a series of rainfall events, the effects can clearly be seen in a spike of moisture levels in the topmost layer of the sample. Data from the top layer of CLT is shown in Figure 9 with the dotted red line indicating the day of transport from Penticton to the building site at UBC. The rapid decrease of sample moisture demonstrated the drying ability of the fully-exposed CLT. These observations of the CLT are consistent with observations which were made in later analysis of the in-building moisture levels during construction.

IN BUILDING MOISTURE

Sensors were installed into floors from below after the first layer of ceiling drywall was installed. Sequencing caused the data collecting units to be uninstalled and reinstalled a total of 3 times for each location. This re-installation took place to ensure the largest dataset possible. Detailed in this section of the paper is the methodology of transferring equipment from the transportation portion of the study and challenges which were overcome to gather the best picture of building moisture performance during construction. Points of interest and trends were discovered while monitoring the mass timber structure with over 300 sensors in a real-time cloud monitoring system. These sensors will remain in the building for its lifetime.

Monitoring Locations

Locations were selected with the intent of obtaining data representative of the majority of environmental and construction related factors that are present during different phases of construction. Instrumentation accounted for points where CLT was uncovered, cement pours took place, floors changing from passive to active heating as active heating as the seasons shifted from summer to winter and material staging in the East wing. Recording a dataset that a dataset that will be representative of the entire building during occupancy was also considered as monitoring will continue throughout the life of the building. Every second floor was monitored and areas alternated between North-South and East-West locations as shown in Figure 10 and

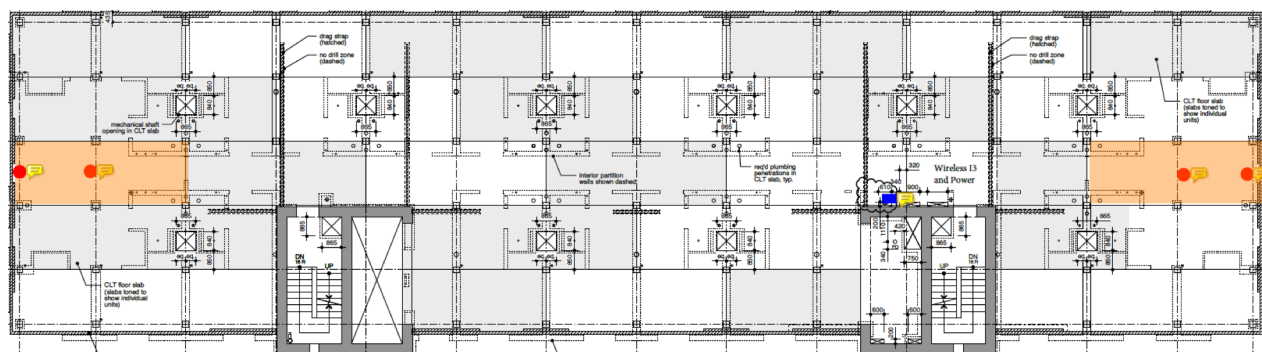

Figure 10: East West Moisture Monitoring Locations

Figure 11.

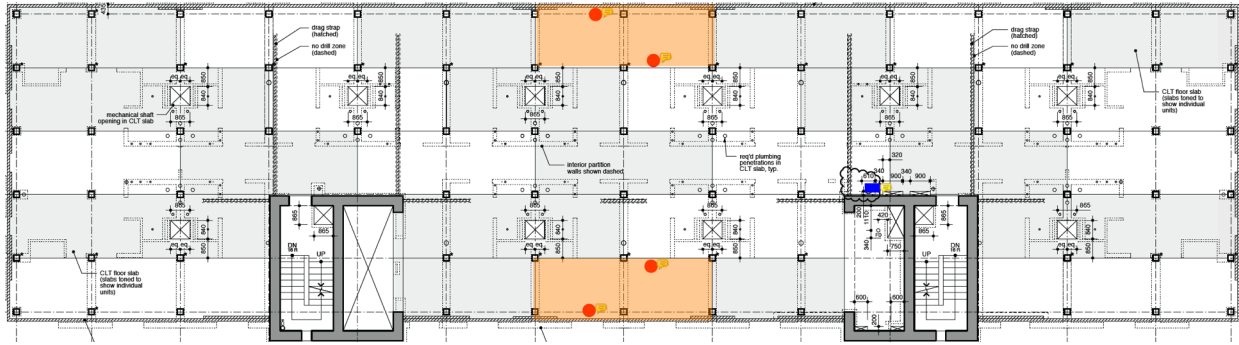

Figure 11: North South Moisture Monitoring Locations

Probe Depths and Orientation

Moisture probes were installed into the CLT panels in the Tallwood House onsite at UBC. Point Moisture Measurement Sensors (PMMs) were installed in alternating East-West and North-South panels on every second floor. The orientation of the PMMs and their depths were installed identically to the transportation study as illustrated in Figure 2.

Key considerations taken in the building study were that MC1B probes are in the plywood spline of non-edge locations. In edge installations MC1B measures moisture at the surface level as close to the edge of the panel as reasonably possible. These layouts are documented in the figures below

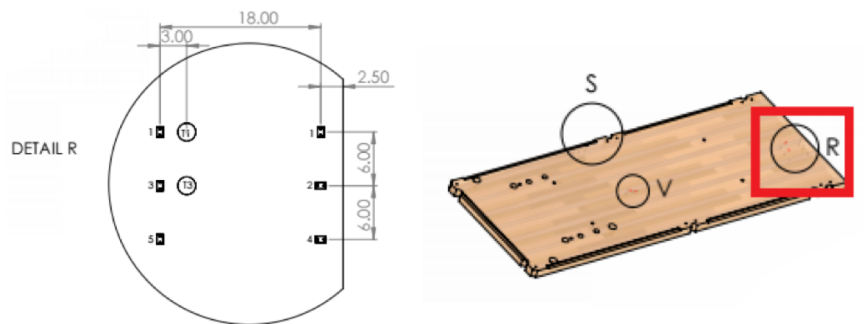

Figure 12: Edge Panel Moisture Probe Locations

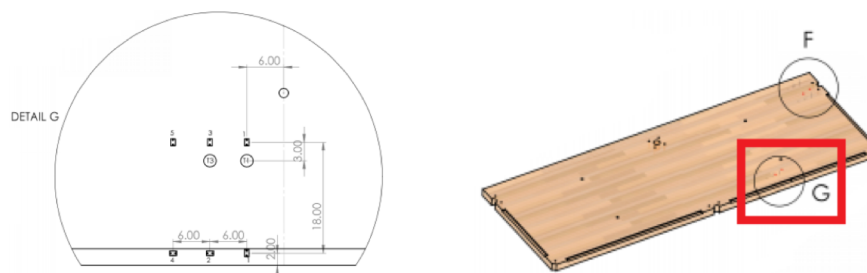

Figure 13: Plywood Spline Moisture Probe Location

Building Element Completion

While monitoring the moisture performance of the CLT panels within the building, the panels were exposed to various events that ranged from rainfall before building enclosure to construction events as detailed in the table below:

Table 1: Major Building Element Dates In Regard to Moisture Control (Kasbar, 2017)

Building Element	Start Date	End Date
Mass Timber Structure (L2 to L18)	6/6/2016	8/11/2016
Envelope Panels (L2 to L19 Parapet)	6/21/2016	9/8/2016
On-site Water Sealer (L3 to L18)	6/27/2016	8/19/2016
Concrete Floor Topping (L3 to L18)	7/4/2016	11/8/2016

Moisture performance of the CLT panels was analyzed with respect to these events as it was theorized that the CLT panels moisture levels would rise with the completion of the concrete floor topping. However, unless direct precipitation was in contact with the panels, the moisture levels did not change substantially. In event of direct moisture contact CLT panels would then quickly dry to acceptable levels. With the completion of the on-site water sealer used to improve the moisture protection of the CLT panels on-site and envelope panels, the overall moisture performance of the CLT panels became much more resilient to moisture. Year-long moisture performance of one location of the CLT is detailed in Figure 15.

Data Collection and Analysis of Full Building Moisture

As discussed in the transportation study and the previous section, the CLT panels within the building dried to acceptable moisture levels during the year-long monitoring. While collecting data during construction the data-collection units had to be removed and reinstalled several times to work within the schedule of other contractors. This process can be refined in the future with increased conversation between contractors and involvement with the sequencing schedule. In Figure 14 CLT moisture performance after an exposed rainfall event is shown

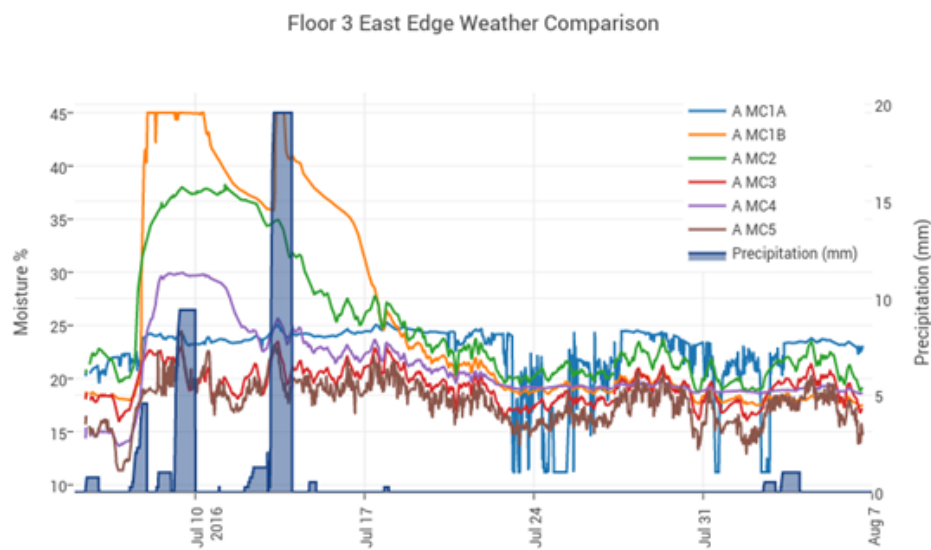

Figure 14: CLT Moisture Performance After Exposed Precipitation Event

In Figure 15, moisture data collected over the course of a year is shown with precipitation as represented by the the blue bars. Despite periodic precipitation, the CLT continued to dry during construction and after the building had been closed. The red area is a gap in data due to removal and reinstallation of the data collection unit to work around other contractors.

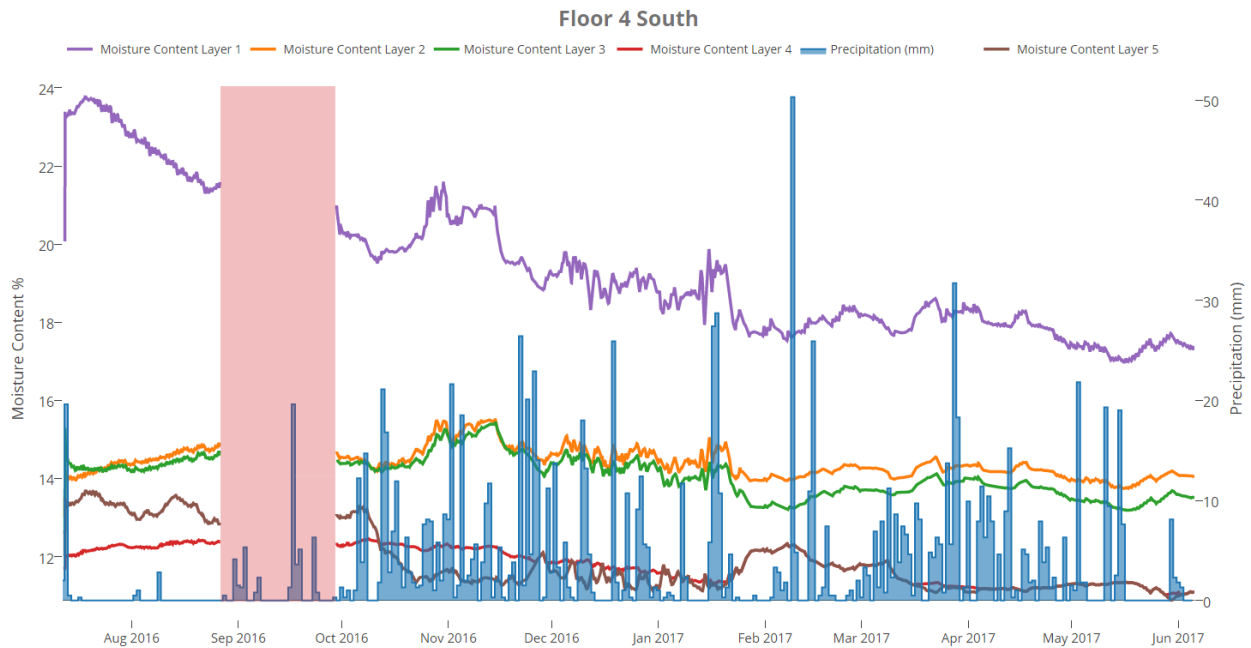

Figure 15: Year Long CLT Moisture Performance

VERTICAL MOVEMENT AND CLT COMPRESSION MONITORING

Timber constructed buildings are susceptible to vertical movement due to the inherent deformation and compression of wood components and building settlement (creep). The construction of an 18 storey, 53-meter building presents an excellent opportunity to evaluate the vertical movement of a building of this magnitude.

Wood components of the building are as follows:

Glulam Columns: 78 glulam columns per floor except level 18, equating to 1302 columns in the building.

CLT Panels: 29 5-ply panels per floor, equating to 464 panels on 16 floors equating to a weight of 954 tons.

Total volume of wood in the building is 2233 cubic meters

The total measured deflection will be used to validate the calculated vertical movement allowing engineers to assess the impact on provisions made for the axial column shortening. The main concerns of axial shortening are the impact on vertical mechanical services as well as movement between the wood structure and concrete core (Fast and Jackson, 2017).

The axial column shortening was calculated to be 48mm. Of this, an estimate of creep and joint settlement is 12mm as shown in Figure 16. (Jackson, 2016)

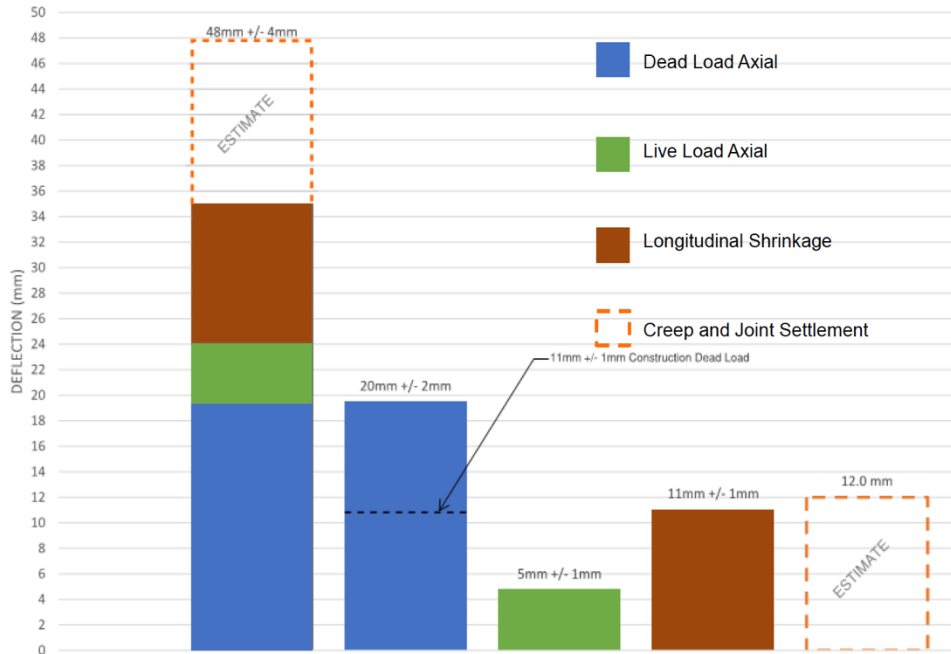

Figure 16: Column Shrinkage Estimation Calculated (Jackson, 2016)

The difference between the axial concrete core shortening and the timber shortening is calculated to be 24mm. Provisions for axial shortening were mitigated by offsetting the connections for the CLT slabs so that they will naturally align after the building settles. (Jackson, 2016)

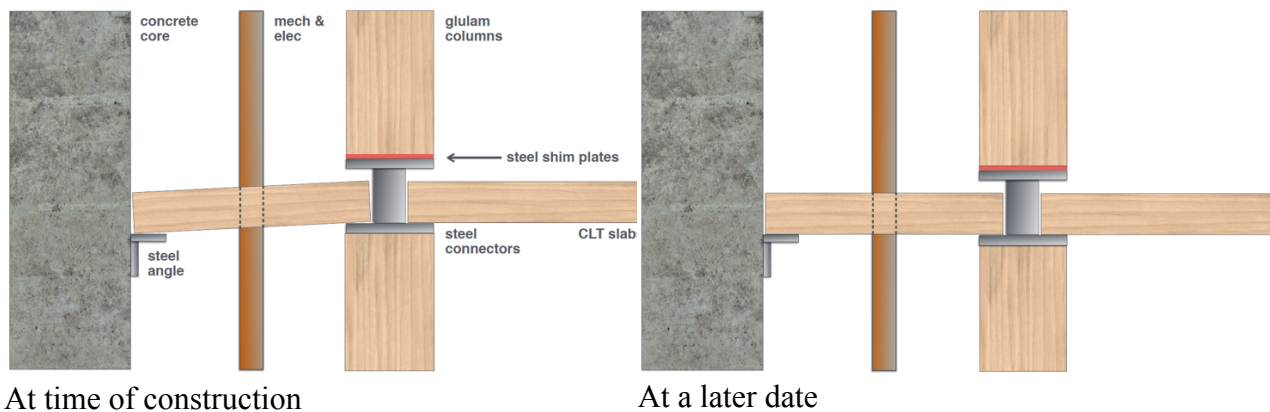

Figure 17: Setting Compensation in Structure Design (Acton, 2016)

Methodology

SMT and FPInnovations published the methodology for Vertical Movement monitoring in [ASTM publication Volume 41, Issue 4](#) (Wang et al., 2013) titled Monitoring of Vertical Movement in Four-Storey Wood-Frame Building in Coastal British Columbia. Several buildings were instrumented using this technology. The same instrumentation and methodology was applied to the UBC Brock Commons Tallwood House.

The measurement method consists of using a string pot sensor that contains a cable actuated position sensor connected to a spring loaded spool. The string is elongated using downrigger stainless steel non stretch cable and connects from the base of a selected column to the top of the floor above capturing the compression of the CLT and wood column.

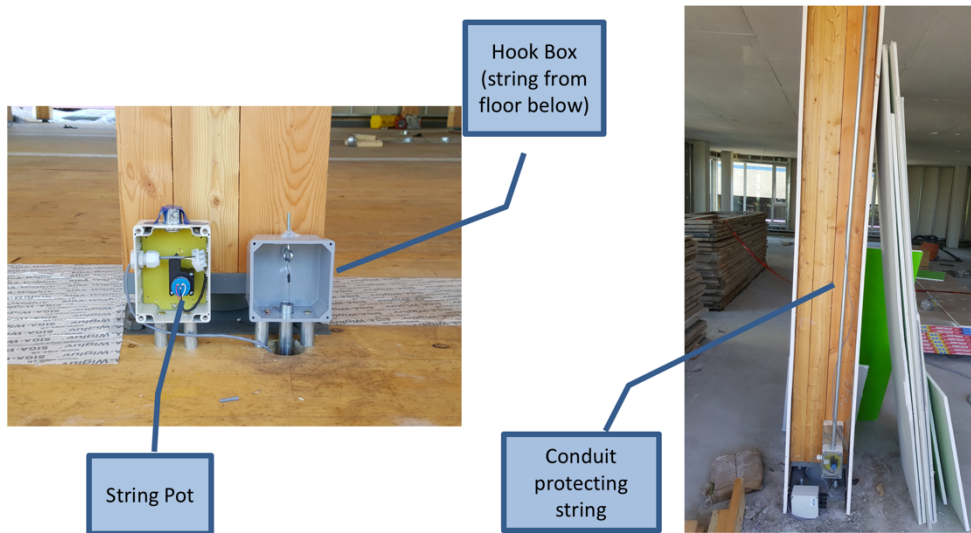

Figure 18: String Pot Units installed In Structure

CLT columns from the base to the floor above were instrumented on the lower four inner floors and an all exterior columns extending up all 18 floors. The locations are shown in Figure 19.

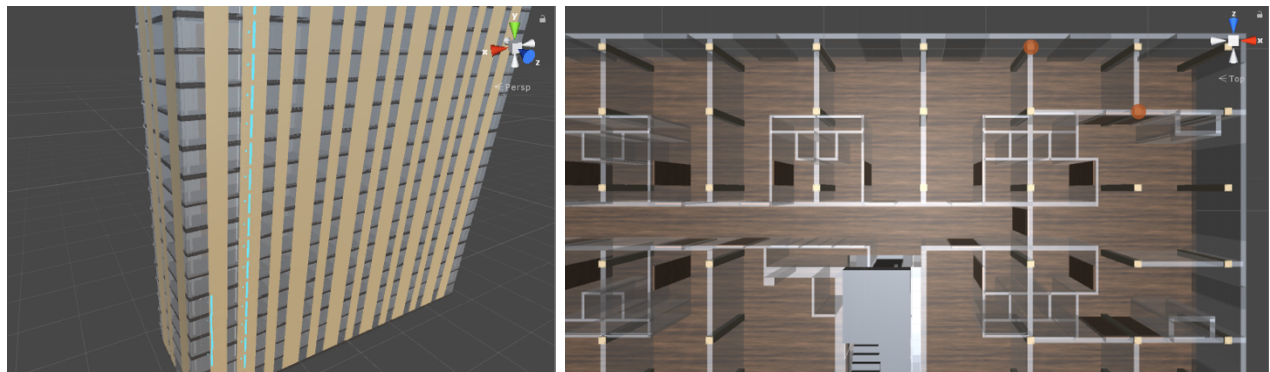

Figure 19: String Pot Locations

Results

Upon commissioning, the sensors started at 0 mm displacement; positive displacement indicates there was an expansion most likely due to the shoring; negative displacement represents vertical compression. Figure 20 shows the vertical displacement of selected string pot sensors during construction. Vertical displacement sensors were disturbed by shoring used to support outriggers during construction.

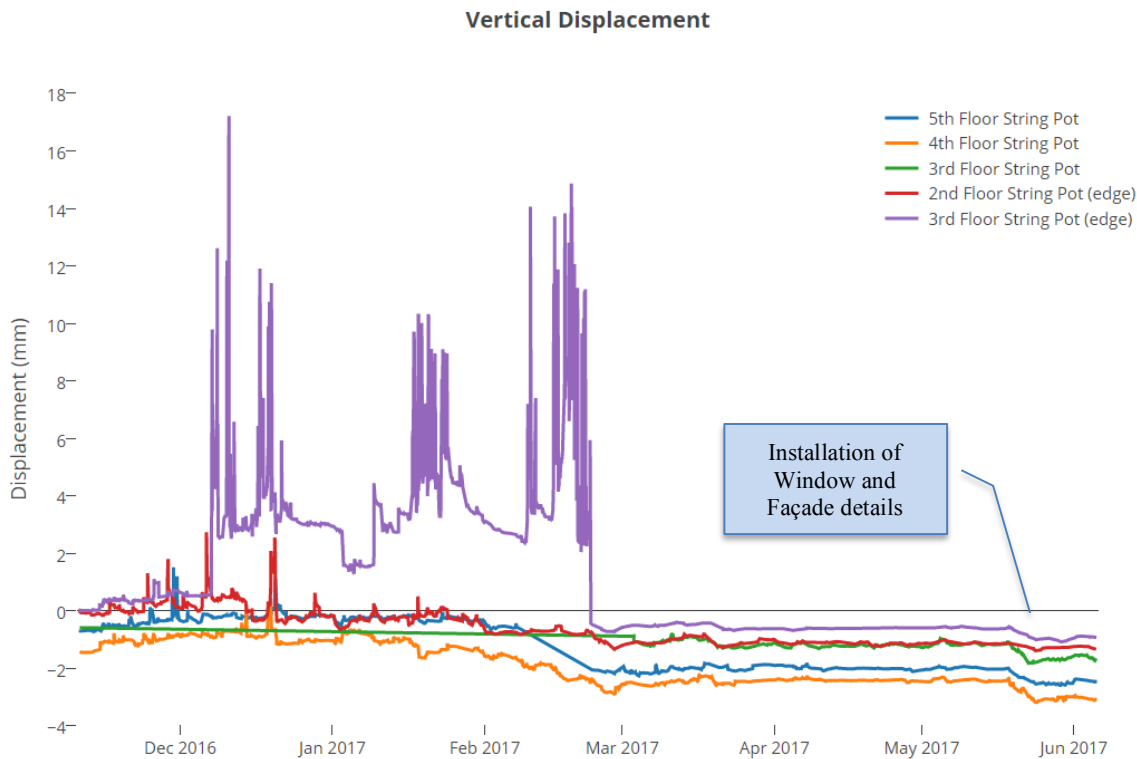

Figure 20: Vertical Displacement Sensor Data

Table 2: Displacement Data as of June 2017

Floor	Displacement After Shoring Removed	Total Displacement June 2017
2 (edge)	-0.960 mm	-1.387 mm
3 (edge)	-0.567 mm	-1.077 mm
3	NA	-1.821 mm
4	-2.577 mm	-3.182 mm
5	-2.052 mm	-2.604 mm

Data Collection and Analysis of Vertical Displacement

The shoring adversely affected the string pots while it was installed however after it was removed it did not appear to offset or skew the measurements. The edge columns and inner columns tracked each other as expected and the displacement on the outer column was less than the inner column as expected. Approximately 1mm displacement was observed on all floors in May 2017, this occurred when the window and façade details were completed on the end units after the outriggers were removed.

Displacement data from all 17 floors will be collected and compared with the compression models. Additional compression is expected to occur once the building is fully occupied and actual and dead loads are applied. In future large scale mass-timber buildings, columns closer to the core will be monitored as it is evident the load on the inner columns will experience more load than the edge columns.

CONCLUSION

The UBC Brock Commons Tallwood House presented a unique opportunity to instrument a structure with forward thinking in design and construction. Gathering imperial data during the various stages and conditions facilitated the assessment of the processes used and allowed adjustments for continuous improvement during the construction process. The moisture mitigation of the CLT panels worked well and despite wetting during construction the panels dried to acceptable moisture levels during the year long monitoring process. The vertical displacement of the edge and inner columns tracked each other and settled as expected. The lessons and information gathered from the structure thus far and in the future as the building will be continuously monitored for its lifetime will prove to be invaluable to similar innovative projects in the future.

REFERENCES

- Acton, R. 2016, November 3. Acton Ostry Architects - Tallwood House Brock Commons University of British Columbia.
- Fast, P., and Jackson, R. 2017, June. BROCK COMMONS A Case Study in Tall Timber. Structure Magazine, : 50–52.
- Fraser, K. 2016, November 3. UBC BROCK COMMONS PROJECT. Available from <http://www.woodworks.org/wp-content/uploads/FRASER-Kit-of-Parts-Workshop-California.pdf> [accessed 19 June 2017].
- Jackson, R. 2016, November 3. Fast+Epp - Brock Commons Student Residence. Available from http://www.woodworks.org/wp-content/uploads/2016-Tall-Timber-Workshop-Brock-Commons_Jackson.pdf [accessed 19 June 2017].
- Kasbar, M. 2017, May 2. INVESTIGATING THE PERFORMANCE OF THE CONSTRUCTION PROCESS OF AN 18-STOREY MASS-TIMBER HYBRID BUILDING. Text, The University Of British Columbia, Vancouver. Available from <https://open.library.ubc.ca/cIRcle/collections/ubctheses/24/items/1.0347252>.
- Sills, N. 2016, November 3. Structurlam - Base 3D Model Geometry to Product Delivery.
- Wang, J. 2015. Field Measurement of Vertical Movement and Roof Moisture Performance of the Wood Innovation and Design Centre: Instrumentation and 1st Years Performance. FPInnovations Special Publication,.
- Wang, J., Ni, C., and Mustapha, G. 2013. Monitoring of movement in a 4-storey wood frame building in Coastal British Columbia. Journal of Testing and Evaluation, 41(3): 611–618.

ACKNOWLEDGEMENTS

We gratefully acknowledge the financial support of BC Housing through the Building Excellence Research & Education Grants Program.